

## 外观

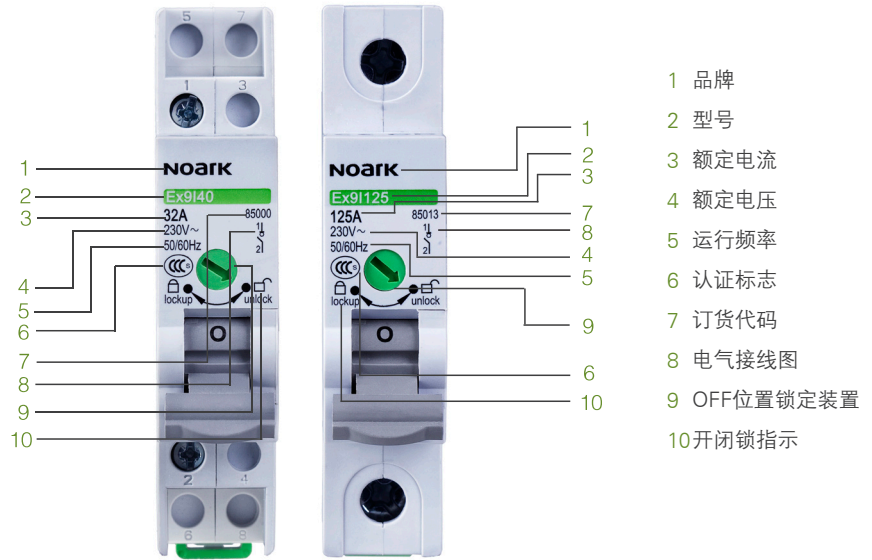

## 特性

Ex9I40、Ex9I125系列交流隔离开关基于Ex9B系列平台，外形尺寸与Ex9B系列一致

其功能如下：

- 带负荷分断和接通线路
- 隔离功能

操作机构的安全可靠性高

人性化OFF位置锁定设计

状态指示更安全

依据内部触头的ON/OFF状态，进红/绿颜色指示，确保状态可视化

优化尺寸设计

标准及认证

符合IEC/EN 60947-3和GB 14048.3标准

Ex9I40系列隔离开关，1P~4P  
宽度尺寸均为18mm

## 选型

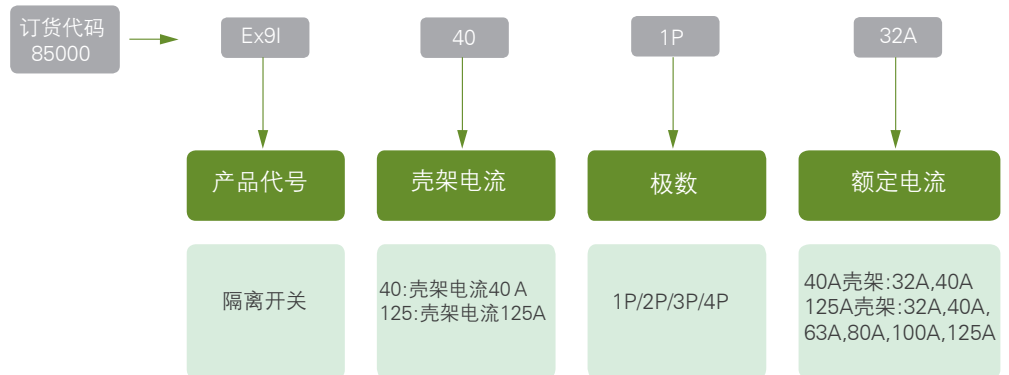

## SD Ex9I隔离开关

### 选型

Ex9I隔离开关										
一般配电保护用 ( IEC/EN 60947-3; GB 14048.3 )										
极数		1P	2P	3P	4P	1P	2P	3P	4P	
壳架等级额定电流	A	40				125				
电气性能										
额定工作电压	Ue	VAC	230/400							
额定绝缘电压	Ui	V	500							
额定电流	In	A	32、40		32、40、63、80、100、125					
额定短时耐受电流	le 1s		12							
额定短路接通能力	le (t=0.1s)		20							
使用寿命 (O~C)	机械	实际平均值	20000							
		标准规定值	8500							
	电气	实际平均值	4000							
		标准规定值	1500							
连接与安装										
防护等级	所有侧面		IP40							
	接线端口		IP20							
安装方式			TH35-7.5/DIN35导轨安装							
使用类别			AC-22A							
接线能力	mm <sup>2</sup>		硬线/软线: 1~10		硬线: 10~50; 软线: 10~40					
使用环境温度	°C		-30至+70							
抗湿热性			2类							
海拔	m		≤2000							
空气相对湿度			+20°C时, 不超过95%; +40°C时, 不超过50%							
污染等级			2							
安装类别			III级							
安装环境			无显著振动和冲击的地方							
外形尺寸(mm) 宽×高×深		a	18	18	36	54	72			
		b	89						89	
		c	80						80	
重量	kg	0.06	0.09	0.18	0.27	0.36				

### 订货代码

类型	宽度 mm	额定电流 A	额定电压 V AC	订货代码	最简规格代码
	18	32	230/400	85000	Ex9I40 1P 32A
	18	40	230/400	85001	Ex9I40 1P 40A
	18	32	230/400	85002	Ex9I40 2P 32A
	18	40	230/400	85003	Ex9I40 2P 40A
	18	32	230/400	85004	Ex9I40 3P 32A
	18	40	230/400	85005	Ex9I40 3P 40A
	18	32	230/400	85006	Ex9I40 4P 32A
	18	40	230/400	85007	Ex9I40 4P 40A

## 订货代码

## Ex9I25隔离开关

类型	宽度 mm	额定电流 A	额定电压 V AC	订货代码	最简规格代码
	18	32	230/400	85008	Ex9I125 1P 32A
	18	40	230/400	85009	Ex9I125 1P 40A
	18	63	230/400	85010	Ex9I125 1P 63A
	18	80	230/400	85011	Ex9I125 1P 80A
	18	100	230/400	85012	Ex9I125 1P 100A
	18	125	230/400	85013	Ex9I125 1P 125A
	36	32	400	85014	Ex9I125 2P 32A
	36	40	400	85015	Ex9I125 2P 40A
	36	63	400	85016	Ex9I125 2P 63A
	36	80	400	85017	Ex9I125 2P 80A
	36	100	400	85018	Ex9I125 2P 100A
	36	125	400	85019	Ex9I125 2P 125A
	54	32	400	85020	Ex9I125 3P 32A
	54	40	400	85021	Ex9I125 3P 40A
	54	63	400	85022	Ex9I125 3P 63A
	54	80	400	85023	Ex9I125 3P 80A
	54	100	400	85024	Ex9I125 3P 100A
	54	125	400	85025	Ex9I125 3P 125A
	72	32	400	85026	Ex9I125 4P 32A
	72	40	400	85027	Ex9I125 4P 40A
	72	63	400	85028	Ex9I125 4P 63A
	72	80	400	85029	Ex9I125 4P 80A
	72	100	400	85030	Ex9I125 4P 100A
	72	125	400	85031	Ex9I125 4P 125A

## Ex9I40隔离开关 Ex9I40 Switch Disconnecter

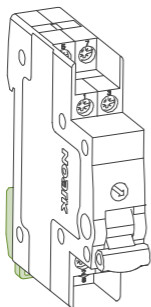

未按本说明书要求操作造成的不良后果，制造商将不承担责任。  
The manufacturer assumes no responsibility for unfavourable consequence resulting from the non-application or incorrect application of the instructions provided herein.

# NOARK 诺雅克

# 1

## Ex9I40隔离开关 Ex9I40 Switch Disconnecter

### 外形尺寸 Appearance Dimension

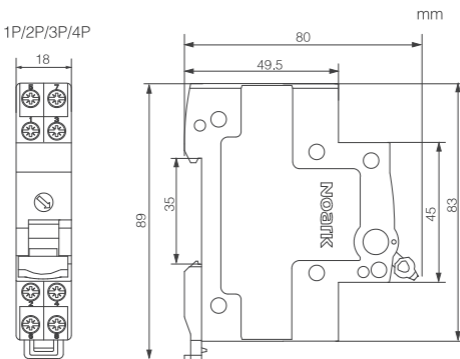

# 2

## Ex9I40隔离开关 Ex9I40 Switch Disconnecter

### 安装步骤 Installation

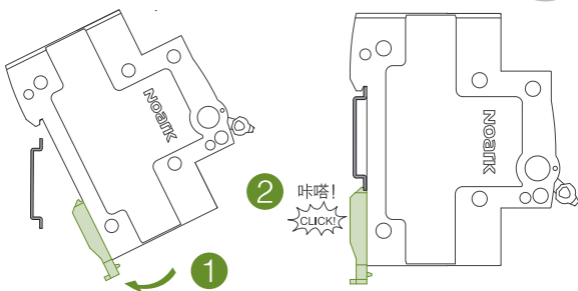

# 3

## Ex9I40隔离开关 Ex9I40 Switch Disconnecter

### 拆卸步骤 Removal

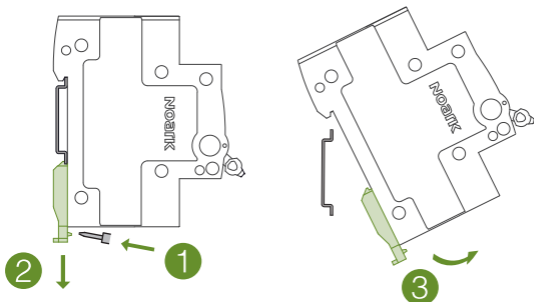





# 4

# Ex9I40隔离开关

Ex9I40 Switch Disconnector

接线 Wiring

# 5

接线工具 Connection tool		 1#螺丝刀 1# screw driver
接线能力(mm <sup>2</sup> ) Wiring capability		1-10mm <sup>2</sup>
拧紧力矩(Nm) Tightening torque		1-1.5N·m

本产品不区分电源端和负载端，故可以根据实际需要采取不同的进线方式，即可上进下出，也可下进上出。

Power supply to the device can be either from the top to the bottom or from the bottom to the top.

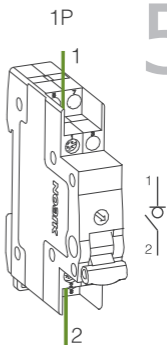

# Ex9I40隔离开关

Ex9I40 Switch Disconnector

接线 Wiring

# 6

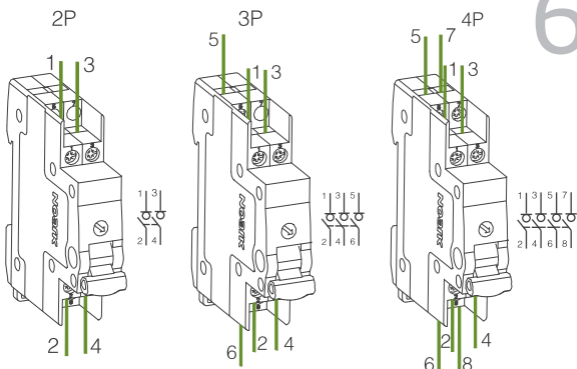

# Ex9I40隔离开关

Ex9I40 Switch Disconnector

锁定操作 Lockup

# 7

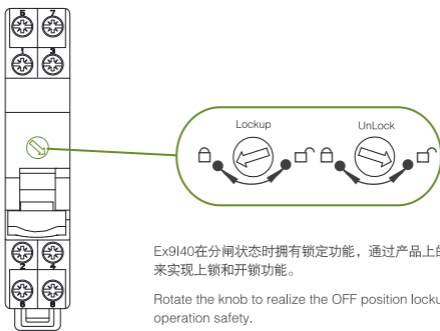

Ex9I40在分闸状态时拥有锁定功能，通过产品上的旋钮来实现上锁和开锁功能。

Rotate the knob to realize the OFF position lockup for operation safety.

上海诺雅克电气有限公司

NOARK Electric (Shanghai) Co., Ltd.

地址：上海市松江区文合路855号

Add: 855 Wenhe Road, Songjiang District, Shanghai

电话：+86-21-3779 1111

Tel: +86-21-3779 1111



采用环保纸印刷

Printed with environment-friendly paper

本说明书解释权归NOARK所有。

The expression right of the instructions are owned by NOARK.

客服热线 / Customer Service Hotline:



400-1092-111

Z9I40201109CE